

QUICK START MANUAL

AC Trip Unit
Manual v4.0

AC-PRO-II®

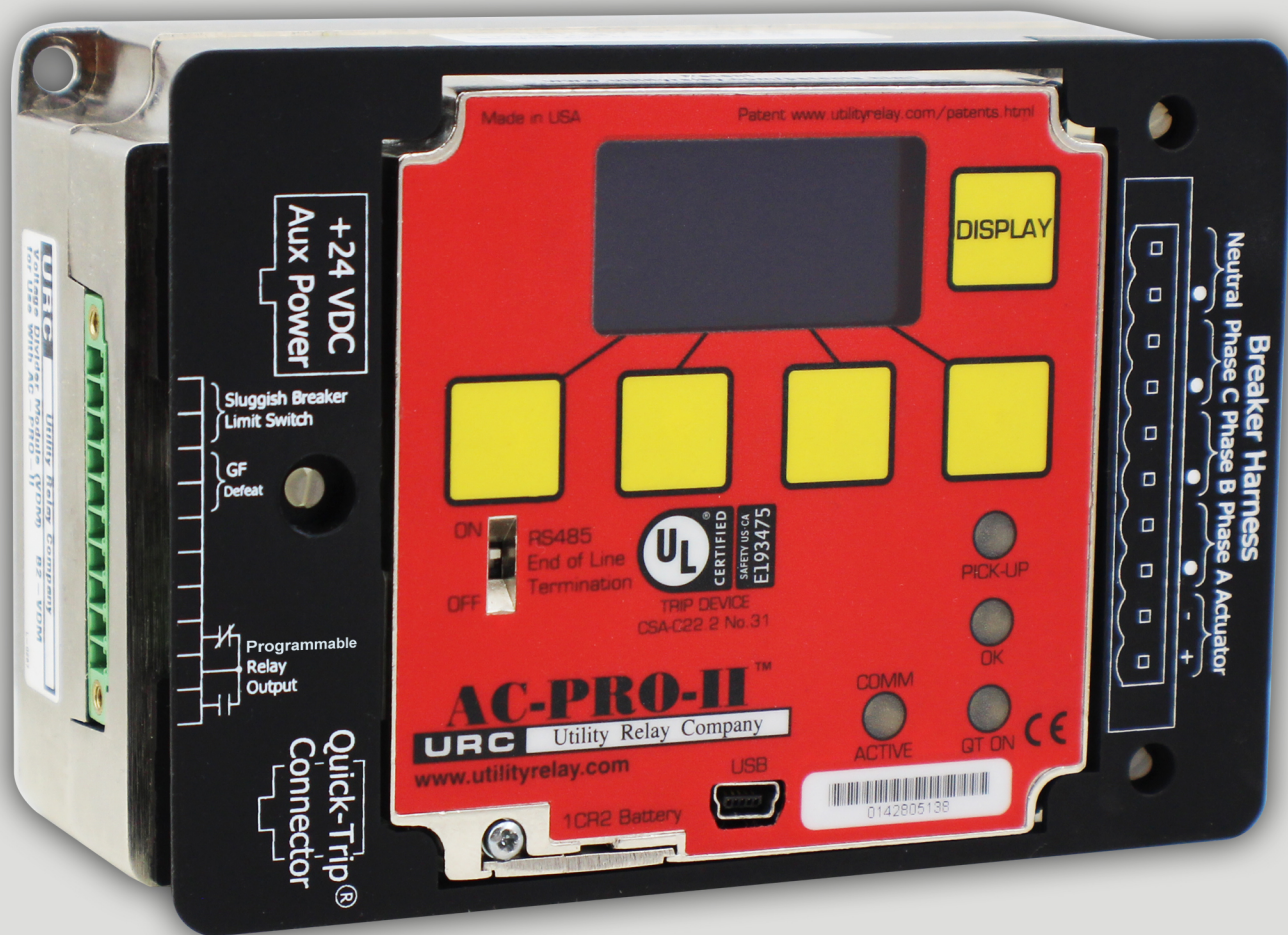

State of the Art Technology for
Low Voltage Circuit Breaker Modernization

URC Utility Relay Company
UTILITYRELAY.COM

10100 QUEENS WAY
CHAGRIN FALLS, OH 44023
USA
888.289.2864

This is an abbreviated “Quick Start” Manual.
 For full version of AC-PRO-II Instruction Manual, visit:
http://www.utilityrelay.com/Side_Bar/Instruction_Manuals.html



Manual Revision 4.0 – May 2022

Table of Contents

| Section: | Page |
|---|------|
| 1.0 Introduction and Product Overview | 1 |
| 2.0 Commissioning the AC-PRO-II® | 2 |
| 2.1 Security Code | 2 |
| 2.2 Time and Date Setting | 2 |
| 3.0 Rotating the Display | 2 |
| 4.0 Testing | 3 |
| 5.0 Menu Navigation | 3 |
| 6.0 External Connections | 4 |
| 7.0 QUICK-TRIP® System | 6 |
| 7.1 QUICK-TRIP® Basics & Operation | 6 |
| 7.2 AC-PRO-II QUICK-TRIP® Switch Mounting..... | 7 |
| 7.3 Remote QUICK-TRIP® Switch | 7 |
| 7.4 QUICK-TRIP® Remote Indication | 7 |
| 8.0 USB Extension cable | 8 |
| 8.1 USB Extension Cable Installation..... | 8 |
| 9.0 Normal Operations & Readings..... | 9 |
| 10.0 InfoPro-AC™ Software Application..... | 9 |
| 11.0 Firmware Versions and Updates | 9 |
| Appendix A – Time Current Curves (TCC)..... | 10 |
| Appendix A.1: Overload TCC | 10 |
| Appendix A.2: Ground Fault (GF) TCC | 11 |
| Appendix A.3: Neutral Overload (NOL) TCC | 12 |
| Appendix A. 4: QUICK-TRIP Ground Fault and QUICK-TRIP Instantaneous TCCs | 13 |
| Appendix A. 5: Phase Current Unbalance TCC | 14 |

1.0 Introduction and Product Overview

The AC-PRO-II® is a state of the art, micro-controller based trip unit for use on three phase, 600 Volt class, AC circuit breakers on 50 Hertz or 60 Hertz systems. The AC-PRO-II features a rotatable 128 x 64 Multi-line, Organic Light Emitting Diode (OLED) Display, smart buttons, and LEDs.

The standard AC-PRO-II features:

- Overload and fault protection
- RS485 communications
- QUICK-TRIP® arc flash hazard reduction ready
- Patented Sluggish Breaker® detection
- Time stamped trip history with waveform capture
- InfoPro-AC™ software interface
- Ready for SAFE-T-TRIP® hand-held remote trip device
- And many other features

Additionally, with the optional Voltage Divider Module (VDM™), the AC-PRO-II can provide voltage and power measurements and advanced voltage protection -- Over/Under Voltage protection, Phase Loss/Reversal trip & alarm, and Reverse Power trip and alarm. (V4 firmware). The VDM provides continuous trip unit power and RS-485 communications even when the breaker is open.

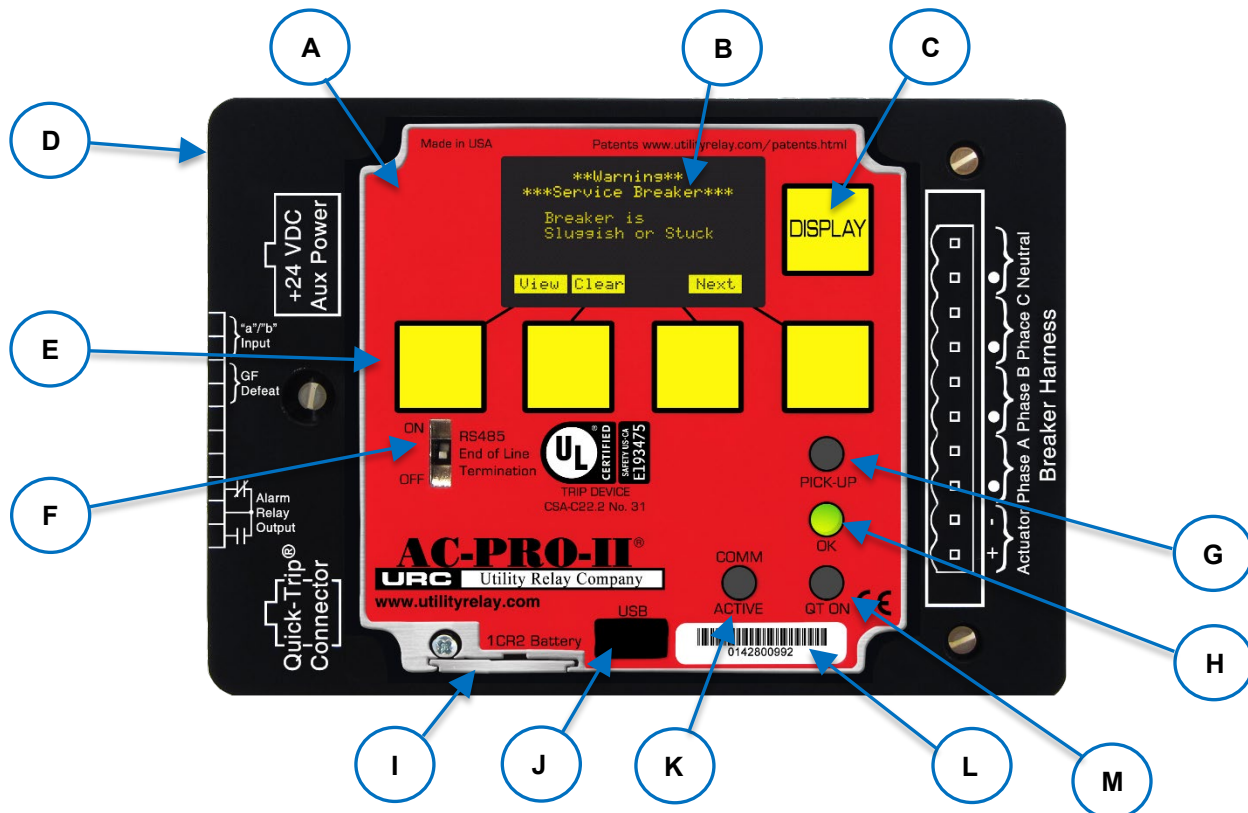

Figure A: AC-PRO-II Front View Horizontal Configuration
 (See page 2 for Item descriptions)

Refer to Figure B on page 1 for items below:

- A. Local Display (rotatable)**
The Local Display is normally mounted to the trip unit. It can be rotated or separated from the trip unit for specific breakers where space is limited.
- B. OLED Display**
The display is normally off. Pushing the "DISPLAY" button (C) turns on the display. The OLED displays the following information. Refer to Section 5.0 for menu navigation.
- 1) Power menu
 - 2) Settings menu
 - 3) Trip history menu
 - 4) More Menu (Trip Unit info & Utilities)
 - 5) Errors, alarms, and other messages
 - 6) QT (DISPLAY) menu
- C. DISPLAY Push Button**
Pushing the "DISPLAY" button will turn on the display. If no buttons are pushed for 60 seconds, the display will turn off.
- D. Removable wire cover**
Cover with printed connection labels. See Section 6.0 for external connections (behind cover).
- E. "Smart" Push Buttons**
These push buttons perform the functions indicated on the bottom of the OLED display. These buttons are used for all menu navigation.
- F. RS-485 Line Termination Switch**
This switch should be placed in the ON position only if the trip unit is the last in the RS-485 communications wiring run.
- G. Red PICK-UP LED**
This LED will illuminate if the current exceeds the LT pick-up setting.
- H. Green OK (Self-Test) LED**
When the trip unit is powered up, this LED is on and blinking unless a problem is detected. (Note: Firmware prior to Version 4.0 used a solid LED to indicate "OK".) If the trip unit is not powered up, the OK LED will not be on. If the "DISPLAY" button is pressed, the OK LED should come on, unless a problem is detected.
- I. Battery Cover**
To replace the battery, remove the single screw and slide battery cover out, remove the old battery and insert a new CR2, 3-Volt Lithium battery. Replace the battery cover and screw.
- J. Mini-USB Port (shown with cover removed)**
The electrically isolated mini-USB port is available for connection to a laptop/ personal computer for uploading & downloading of settings, information, and firmware; SAFE-T-TRIP remote trip device operation; or USB wall pack for auxiliary power.
- K. COMM ACTIVE LED**
The communications active LED illuminates when the trip unit is transmitting information via Communications.
- L. AC-PRO-II Serial Number**
- M. Quick-Trip LED (red)**
This LED will illuminate if a Quick-Trip switch is connected and on the ON position.

2.0 Commissioning the AC-PRO-II®

Before the AC-PRO-II trip unit is put into service, it must first be commissioned so it will function. This requires the user to enter all of the pick-up and delay settings into the unit.

The commissioning process normally takes less than a few minutes to complete.

The AC-PRO-II can be commissioned using the local display screen, or using the InfoPro-AC software application. If the AC-PRO-II has not been commissioned, it will display "Enter settings before placing into service". Pressing the "SET" button at this screen will begin the settings process. For commissioning using the InfoPro-AC software application, see Section 10.0, and the InfoPro-AC help guide included in the application.

**** IMPORTANT ****

The trip unit will NOT FUNCTION as it is shipped from the factory. The user must first COMMISSION the unit as outlined in this Section.

2.1 Security Code

The security code is the last four (4) digits of the serial number. See Figure A: AC-PRO-II Front View Horizontal Configuration Item L for serial number location.

2.2 Time and Date Setting

The time and date setting is accessed via the MORE menu, by pressing the MORE button at the main screen, then the time button, then the change button. The time and date must be set after commissioning the AC-PRO-II or after replacing the battery to ensure the time stamps (of trips and on-demand waveforms) are recorded and are correct. In order for the time and date to remain accurate after setting, a fresh battery must be in place.

3.0 Rotating the Display

The AC-PRO-II trip unit consists of a main case and a display case. The trip unit orientation can be modified by rotating the display case. Refer to the AC-PRO-II retrofit kit installation manuals for your breaker-specific trip unit orientation.

To rotate the Display Case:

- The breaker must be out of service and de-energized for safety.
- Ensure the person rotating the display is properly grounded and takes special care to avoid static discharge onto trip unit and display internal components.
- Remove the black wiring cover by pulling the wiring cover off the three (3) standoff posts.
- NOTE: the display case is connected to the main case via the following:
 - One (1) Ribbon cable. See Figure C.
 - Four (4) captive screws. See Figure B.
- Loosen the four (4) captive screws with a screwdriver.
- Leave the ribbon cable connected. Do not disconnect the ribbon cable.
- Rotate the display to the position required for the installation on the specific breaker. Be careful not to damage, pinch, or disconnect the ribbon cable.
- Tighten the four (4) captive screws.
- Press the "DISPLAY" button and smart buttons to confirm operation.
- Refer back to the AC-PRO-II retrofit kit Instructions for additional breaker specific steps.

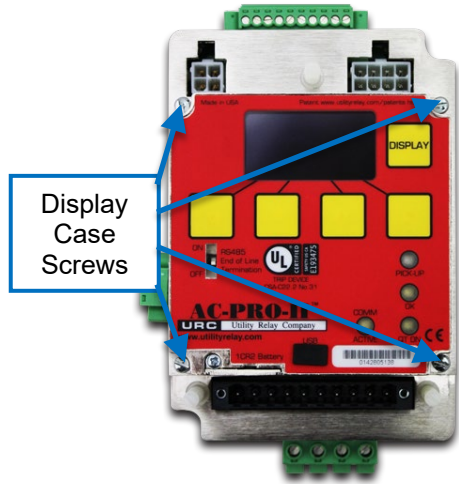

Figure B: Display Case Screw locations

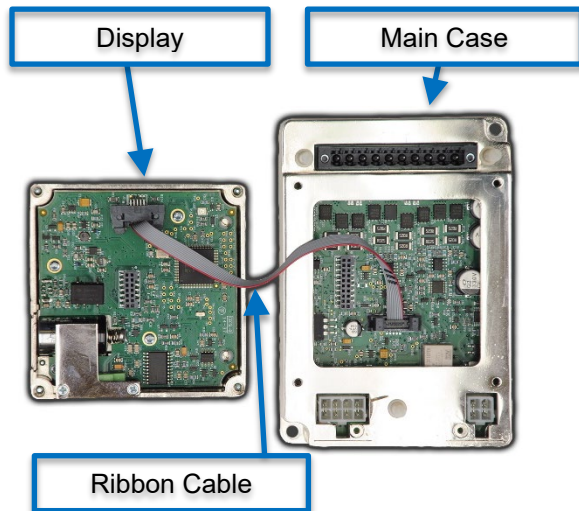

Figure C: Trip Unit and Display (separated)

4.0 Testing

A "primary injection" test is recommended as the final test of the AC-PRO-II retrofit. If residual GF is used, it must be temporarily turned off when testing the other trip functions.

Before proceeding with the normal primary injection tests, the trip unit must be commissioned to make it functional. See Section 2.0 for Commissioning information.

It is best to use the final pick-up and time delay settings if they are known. If not, use typical settings for the primary injection test.

Although primary injection testing is the preferred method to test an AC-PRO-II installation, secondary injection testing can also be used, using URC B-292 Test Set.

See Appendix A for Time Current Curves (TCC). For additional testing information including instructions, and LT Delay Testing Chart, refer to the full AC-PRO-II Instruction Manual. See the link and QR code in the Table of Contents of this document.

5.0 Menu Navigation

AC-PRO-II settings and information can be navigated using the push buttons on the face of the trip unit. Pressing the "DISPLAY" button wakes the display up from its power saving mode. After the display is on, all menu navigation is accomplished using the screen prompts and (4) smart buttons below the display. The smart button labels appear at the bottom of the screen. See the list of menus and sub-menus:

- 1) PWR (Power Menu): This menu provides access to power values, which become available if the optional Voltage Divider Module (VDM) is connected.
- 2) SET (Settings Menu).
 - a. REV (Review Settings sub-menu): This sub-menu allows review of all user settings without the option of changing the settings.
 - b. CHNG (Change Settings sub-menu): This sub-menu allows the user to change all protection, alarm, and breaker information settings.
 - c. TEST (Test Mode sub menu): This sub-menu is for Testing convenience, AC-PRO-II offers a "Test Mode". When the AC-Pro-II is in Test Mode, all Voltage Protection is temporarily disabled, and the need to enter the Security Code to change settings is temporarily disabled. Though Test Mode is automatically turned OFF after 60 minutes, it should always be manually turned OFF after testing is complete.
- 3) HIST (Trip History Menu): This menu provides access to trip history information for up to eight (8) trips.
- 4) MORE (Trip Unit Information Menu): This menu includes serial number(s), time & date settings, battery status, URC contact info, Service Reminder message, etc.
- 5) QT – When at the Main Screen, pressing the DISPLAY button will change the bottom labels at the bottom of the screen. This will allow access to the QUICK-TRIP® mode control. See Figure F for Simple Menu and Section 7.1 QUICK-TRIP® Basics & Operation for additional information.

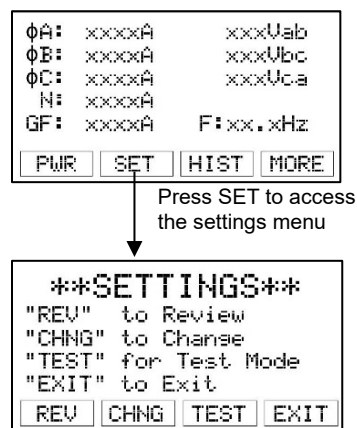
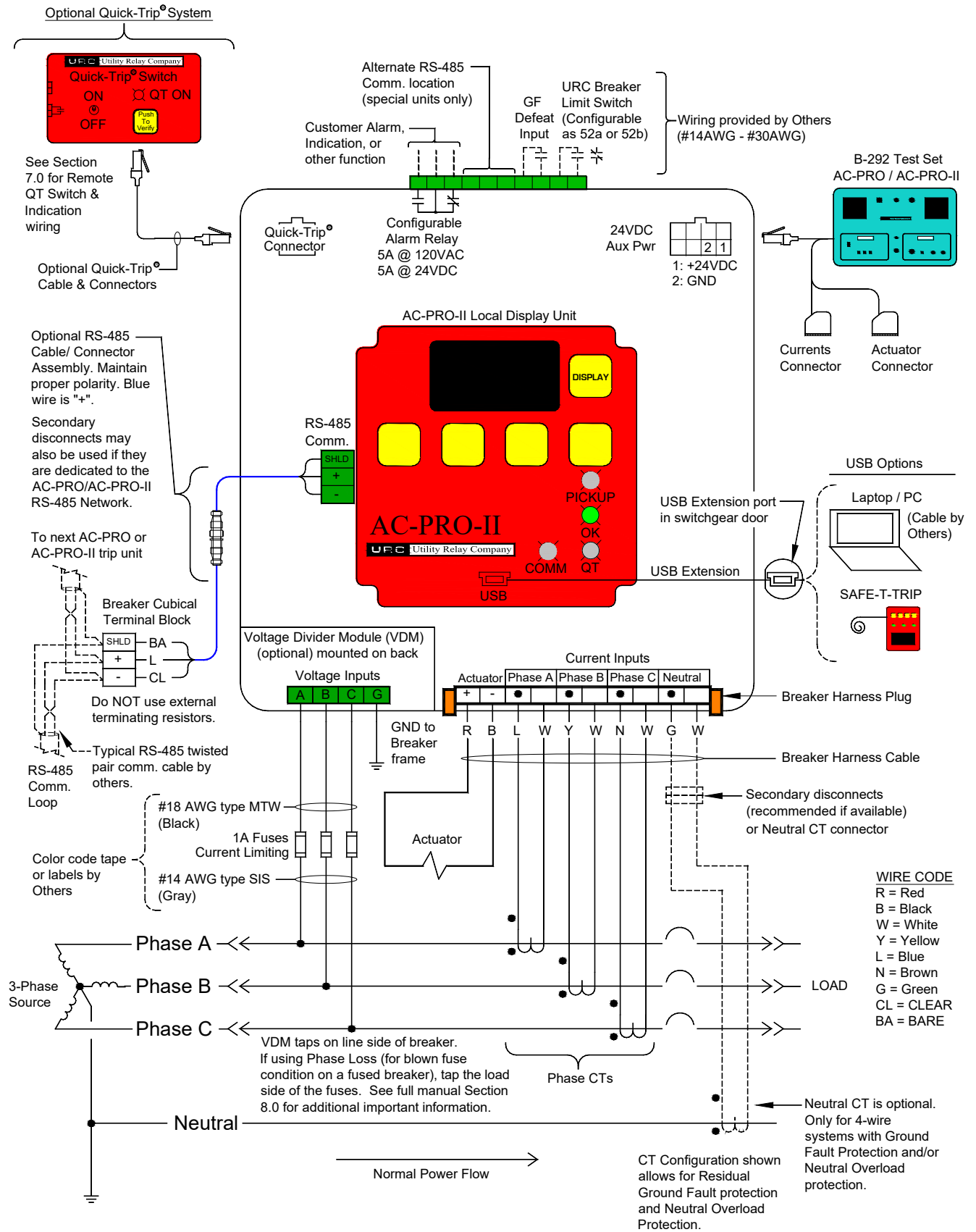

Figure D: Settings Menu first screen

NOTE: Test Mode is an option with Version 2 firmware and later.

6.0 External Connections



WIRE CODE

| |
|------------|
| R = Red |
| B = Black |
| W = White |
| Y = Yellow |
| L = Blue |
| N = Brown |
| G = Green |
| CL = CLEAR |
| BA = BARE |

Figure E: AC-PRO-II Typical Wiring Diagram

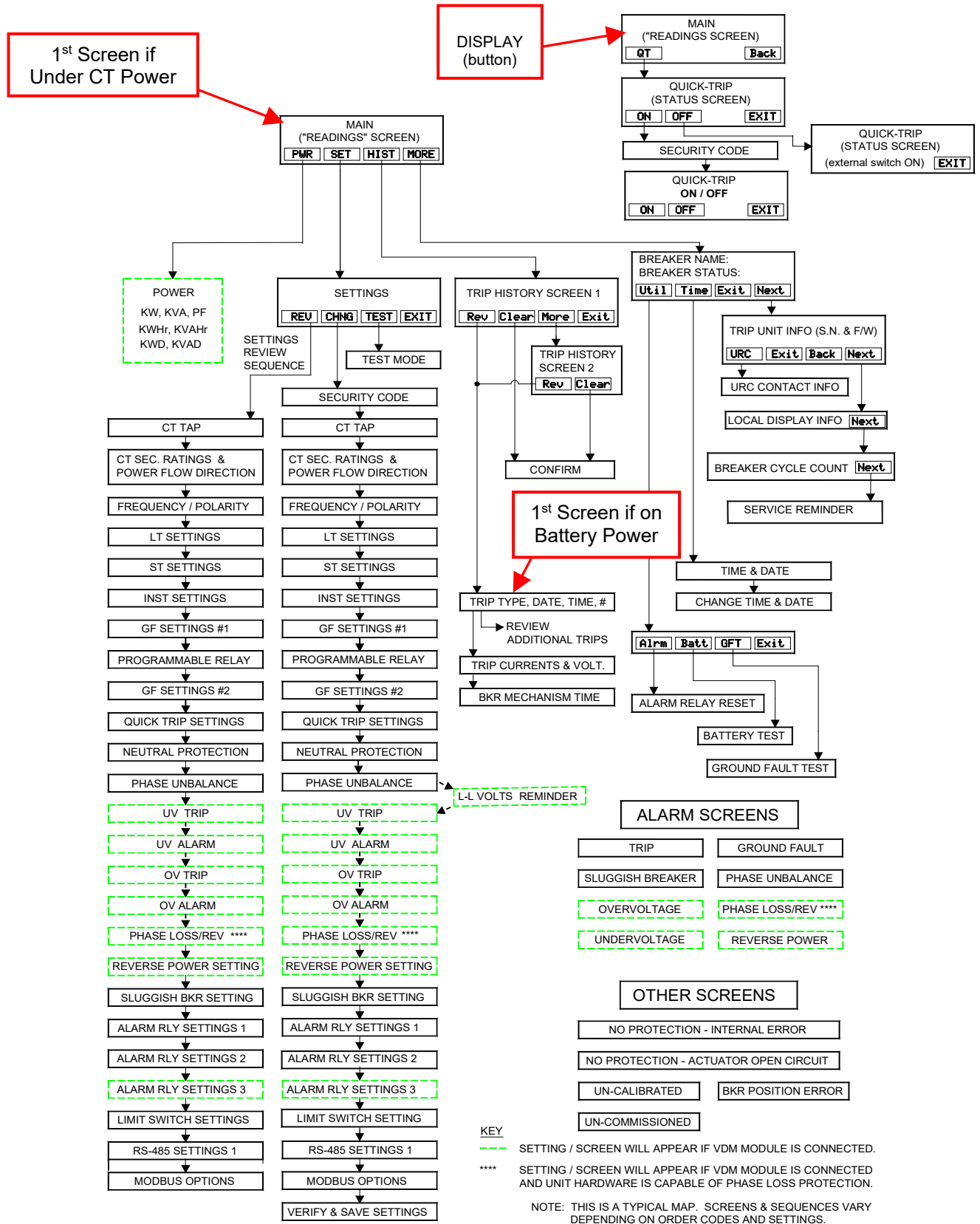

Figure F: Typical AC-PRO-II Menu Navigation Map - Simple View

7.0 QUICK-TRIP® System

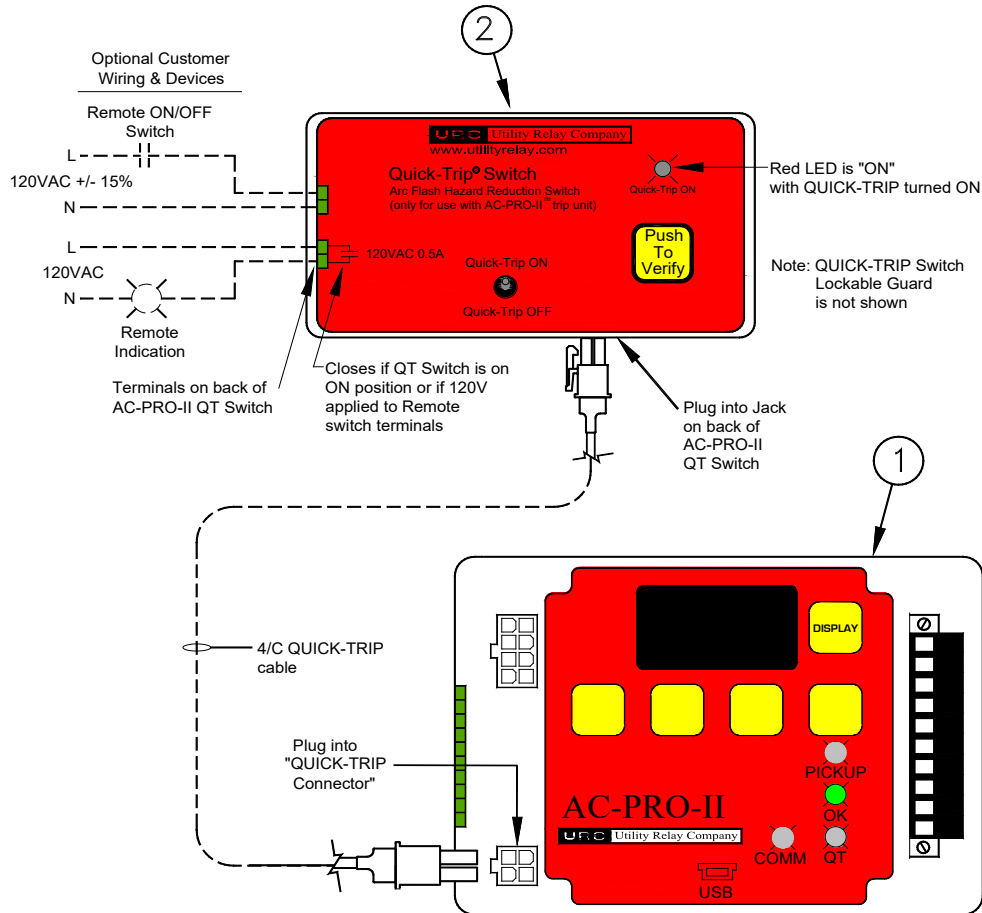

Figure G: QUICK-TRIP System and Connections (Option 1)

7.1 QUICK-TRIP® Basics & Operation

The QUICK-TRIP system is a manually controlled arc flash hazard reduction system. It can reduce trip times when turned on and allows selective coordination between circuit breakers when turned off.

If maintenance personnel must work on energized equipment, they will first turn the QUICK-TRIP system on at the upstream breaker feeding the equipment or breaker. If a fault now occurs, the upstream breaker will trip quickly based on the QUICK-TRIP settings **reducing the Arc Flash Hazard to personnel.**

When the maintenance work is finished, the QUICK-TRIP system is turned off and the original selective coordination is back in effect. The QUICK-TRIP system includes the AC-PRO-II trip unit with the following optional components:

- Option 1: AC-PRO-II QUICK TRIP Switch (URC Part #QT2-SWITCH) consisting of Padlockable QUICK-TRIP On/Off toggle switch, QUICK-TRIP On LED, Push-to-Verify button, Remote Switch Terminals, Remote Indication Terminals and 4/C QUICK-TRIP cables.
- Option 2: AC-PRO-II AC-PRO QUICK-TRIP Switch (URC Part #QT-SWITCH with Padlockable QUICK-TRIP On/Off toggle switch), QT-DISPLAY (with Quick-Trip On LED, Push-to-Verify button, Interface Module (IM) and 8/C QUICK-TRIP cable with connectors.
- Option 3: QUICK-TRIP via KeyPad QT, InfoPro-AC via USB or Smart 1-Line HMI.

When QUICK-TRIP is **on**, the following settings are enabled:

- I QUICK-TRIP (I QT)
- GF QUICK-TRIP (GF QT)

These are standard AC-PRO-II settings. All other settings remain in effect.

The "QUICK-TRIP ON LED" provides positive indication that the QUICK-TRIP settings are active if the LED is on. If the AC-PRO-II is not powered up (by current, voltage (VDM), USB or 24VDC Aux.), the QUICK-TRIP Switch "Push-to-Verify" button is available. Pressing this button will "wake up" the trip unit using the AC-PRO-II battery, and the QUICK-TRIP ON LED will illuminate, providing positive indication that the QUICK-TRIP switch, remote QUICK-TRIP switch is in the ON position or the QUICK-TRIP mode is activated via Keypad QT, InfoPro-AC or Smart 1-Line HMI. See Figure F for QUICK-TRIP Menu commands.

****** NOTE ******

QUICK-TRIP Instantaneous and QUICK-TRIP Ground Fault features can be activated via five (5) methods – (1) QT2 Switch - the AC-PRO-II needs to be physically connected to QUICK-TRIP (QT2) switch; (2) QT switch, QT-DISPLAY and IM connected to AC-PRO-II, (3) AC-PRO-II Keypad QT screen; (4) InfoPro-AC USB software QUICK-TRIP; and (5) Smart 1-Line QUICK-TRIP HMI screen activation. .

****** IMPORTANT ******

A qualified engineer must determine the QUICK-TRIP settings, calculate the incident energy levels and determine the Hazard Risk Categories (HRC).

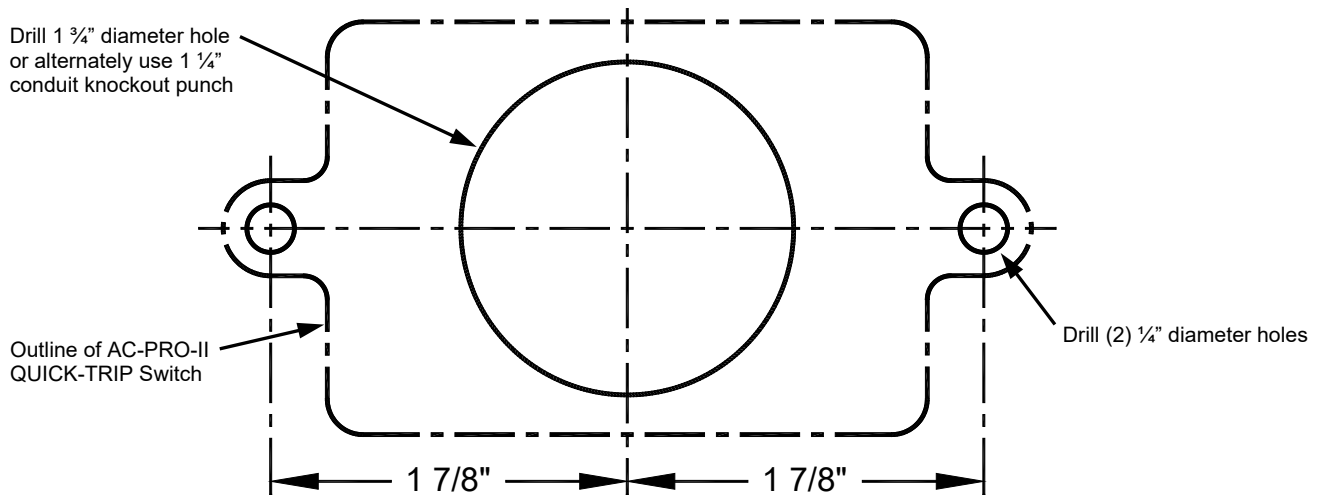

Figure H: AC-PRO-II QUICK-TRIP Switch Drilling Plan

7.2 AC-PRO-II QUICK-TRIP® Switch Mounting

The QUICK-TRIP system is easy to install on the front of the breaker cubicle door.

To install the QUICK-TRIP Switch:

1. Find a suitable location on the cubicle door and mark the location of the three (3) holes using the dimensions in Figure 7.2.
2. Drill two (2) 1/4" mounting holes.
3. For the center hole, cut a 1-3/4" diameter hole using a hole saw or alternately, use a 1-1/4" conduit knockout punch (1.73" D).
4. Attach the QUICK-TRIP Switch to the front of the cubicle door using the two (2) supplied 10-32 screws and lock washers.
5. Connect the QUICK-TRIP Switch to the AC-PRO-II trip unit by plugging one end of the 4/C cable provided into the jack on the back of the QUICK-TRIP Switch. Plug the other end of the cable into the "QT" jack on the front of the AC-PRO-II.
6. Route the cable so it does not interfere with the opening or closing of the cubical door or with the racking of the breaker between connect and disconnect positions. Use cable ties and holders to hold the cable in position.

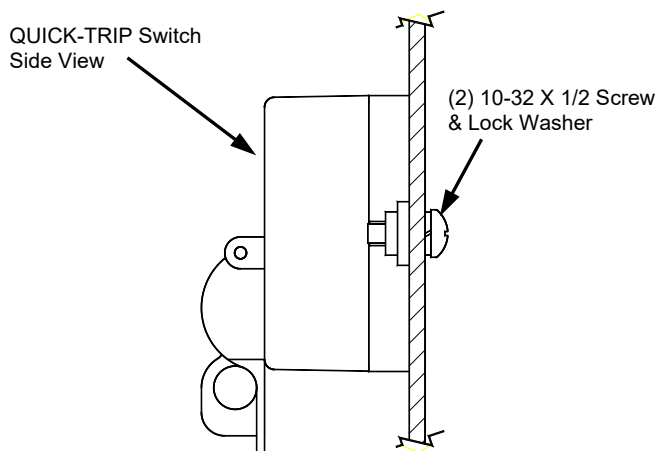

Figure I: QUICK-TRIP Switch Mounting



Figure J: AC-PRO-II Quick-Trip Switch

7.3 Remote QUICK-TRIP® Switch

The AC-PRO-II QUICK-TRIP switch includes terminals on the rear for connection to a remote QUICK-TRIP switch (provided by others).

Refer to Figure G. If 120VAC (+/- 15%) is applied to the remote QUICK-TRIP switch terminals, the QUICK-TRIP settings are activated.

**** NOTE ****

There are a few ways the QUICK-TRIP protection feature can be activated even when the AC-PRO-II QUICK-TRIP toggle switch is in the OFF position – (1) by applying 120VAC to the remote Quick Trip switch terminals; (2) AC-PRO-II Keypad QT Screen; (3) InfoPro-AC Software QUICK-TRIP; and (4) Smart 1-Line QUICK-TRIP HMI screen. Therefore, if a remote QUICK-TRIP switch is installed, URC recommends installing label(s) or nameplate(s) that indicate the presence and location of the remote QUICK-TRIP switch or HMI.

7.4 QUICK-TRIP® Remote Indication

The AC-PRO-II QUICK-TRIP switch includes terminals on the rear for connection to a customer-supplied remote QUICK-TRIP indicating light or other device.

Refer to Figure G. If the QUICK-TRIP System is activated (ON), the Remote QUICK-TRIP trip Indication contacts close. The contacts are rated 120VAC, 0.5A.

8.0 USB Extension cable

If AC-PRO-II is installed on a breaker that is located behind a cubicle door, a USB panel mount extension cable and legend plate is provided in the retrofit kit. This provides a permanent USB connection from the AC-PRO-II to a USB port that is accessible at the cubicle door. The cable (5/C, 6 feet long) features a right angle mini-USB connector for the AC-PRO-II and a USB port with cover, and a threaded nut for securing to the cubicle door.



Figure K: USB Extension cable

8.1 USB Extension Cable Installation

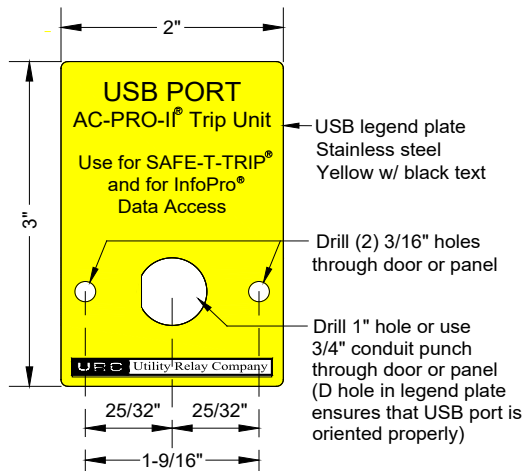

Figure L: USB Extension Plate Drilling

To install the USB Extension cable:

1. Find a suitable location on the cubicle door and mark the three (3) holes using the dimensions in Figure L
2. Drill two (2) 3/16" mounting holes.
3. For the center hole, cut a 1" diameter hole using a hole saw or alternately, use a 3/4" conduit knockout punch.
4. Attach the USB legend plate to the front of the cubicle door using the supplied two (2) 8-32 screws, nuts, and lock washers.
5. Connect the right-angle USB connector to the AC-PRO-II. Route the cable so it does not interfere with the opening or closing of the cubical door or with the racking of the breaker between connect and disconnect positions. Use the supplied cable ties and holders to hold the cable in position.
6. Position the USB port through the 1" opening and through the opening in the legend plate. Ensure one rubber washer is on the interior of the door / panel, and the threaded USB cover and rubber washer are on the exterior.
7. Thread the plastic nut onto the USB port connector, securing it to the door / panel.

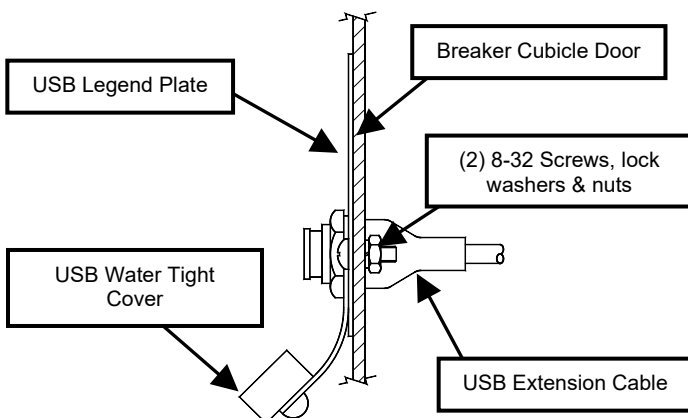

Figure M: USB Extension Plate & Cable Installation

9.0 Normal Operations & Readings

During normal operation, the trip unit display screen will be off and in its power saving mode. When the “DISPLAY” button is pressed during normal operation (no trips, errors, alarms, etc), the trip unit will display current and voltage readings (if equipped with Voltage Divider Module (VDM)). The neutral and GF currents will only be displayed if neutral or GF protective functions are turned on. See below. The “XXXX” digits will display actual readings.



Figure N: Main (“Readings”) Screen

- The left column displays Currents in Amps for Phases A, B, C, Neutral and Ground Fault.
- The right column displays Voltages and Frequency.

Breaker Current Less than 10% of CT Rating:

When the currents are less than about 10% of the CT rating, the display will display “LOW” for currents.

Breaker Current Greater than 10% of CT Rating:

If the breaker current is greater than about 10% of the CT rating, the current readings will be displayed.

Line-to-Line Voltages (if equipped with VDM):

“LOW” will be displayed if the Line-to-Line voltage is 90V or below.
 “N/A” will be displayed if the Voltage cannot be determined, most likely because system voltage (i.e. 480V) is not present at the VDM.

Note: If voltages and voltage labels (“Vab, Vbc, Vca”) do not display, the AC-PRO-II is either not equipped with a VDM, or the VDM is not properly connected to the AC-PRO-II, contact URC.

10.0 InfoPro-AC™ Software Application

InfoPro-AC is a software application that can be used with AC-PRO-II for the following:

- Settings – upload, download, view, save, and print.
- Trip history including waveforms – view, save, and print.
- Waveforms (on-demand) – view, save, and print.
- Current, voltage, & power readings – view.
- Alarms and trip unit status Information
- Trip unit info: serial number, firmware versions, breaker name.
- Firmware updates
- Breaker Control – Trip / Close; QUICK-TRIP Control

Operating System:

Microsoft Windows, ideally Windows 10 and 11.

Connection:

mini-USB (cable not included)

NOTE: if AC-PRO-II is located behind a cubicle door, a USB panel mount extension was provided with the retrofit kit.

The InfoPro-AC™ software application is available for download at:

http://www.utilityrelay.com/Side_Bar/Downloads.html



11.0 Firmware Versions and Updates

To determine which firmware version is currently installed on your AC-PRO-II, use the MORE menu. See Figure E.

The InfoPro-AC application can be used to update AC-PRO-II firmware in the field using the USB port. AC-PRO-II Firmware update instructions can be found in the InfoPro-AC Help Menu. For firmware version information see the following link:

http://www.utilityrelay.com/Side_Bar/Firmware_versions.html



Utility Relay Company
 10100 Queens Way
 Chagrin Falls, OH 44023
www.utilityrelay.com
 Phone 888-289-2864
 Fax: 440-708-1177

For full version of AC-PRO-II Instruction Manual, visit:
http://www.utilityrelay.com/Side_Bar/Instruction_Manuals.html



Appendix A – Time Current Curves (TCC)

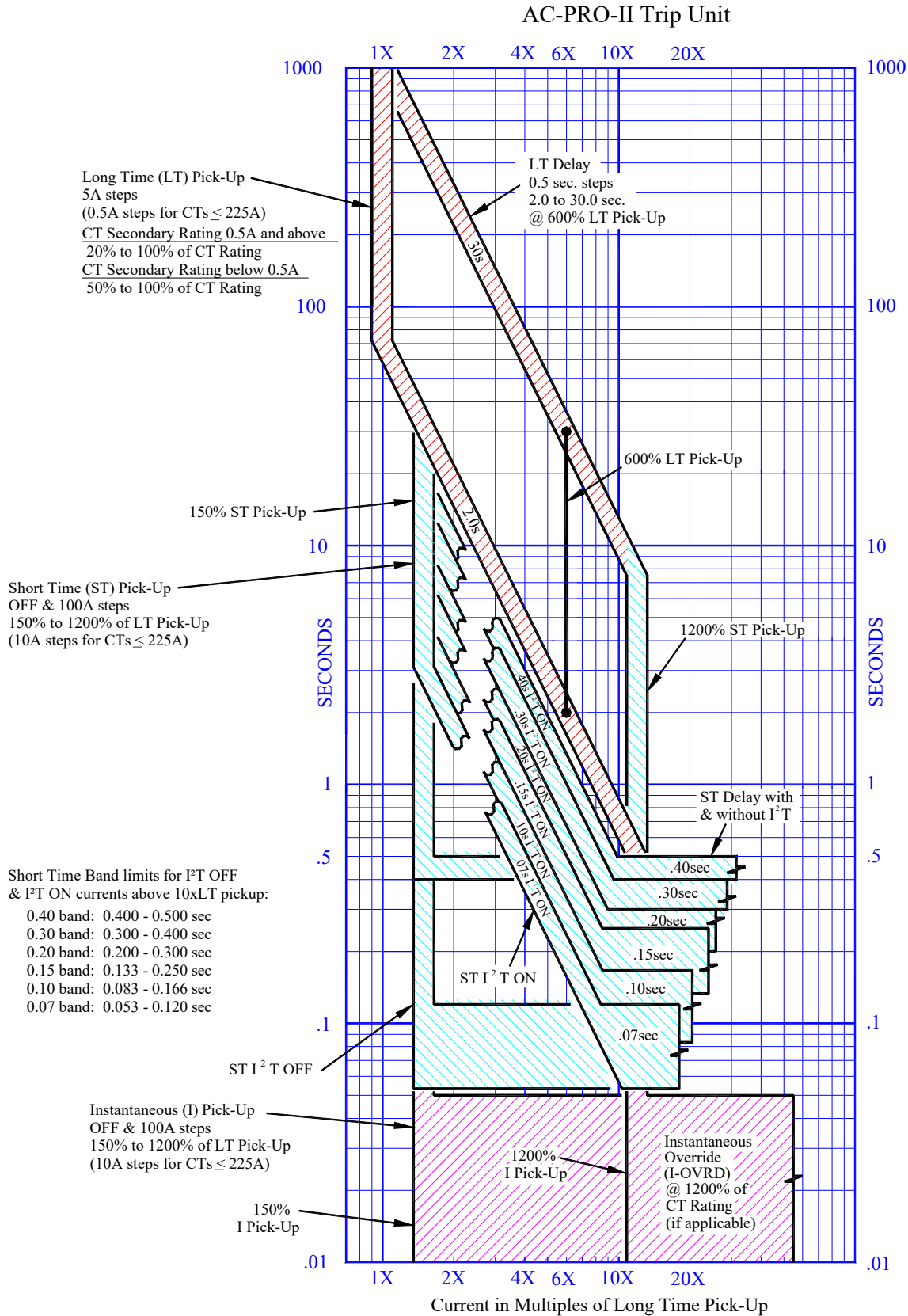

AC-PRO-II O.L. Rev 1.02 08/15/2017

Appendix A.1: Overload TCC

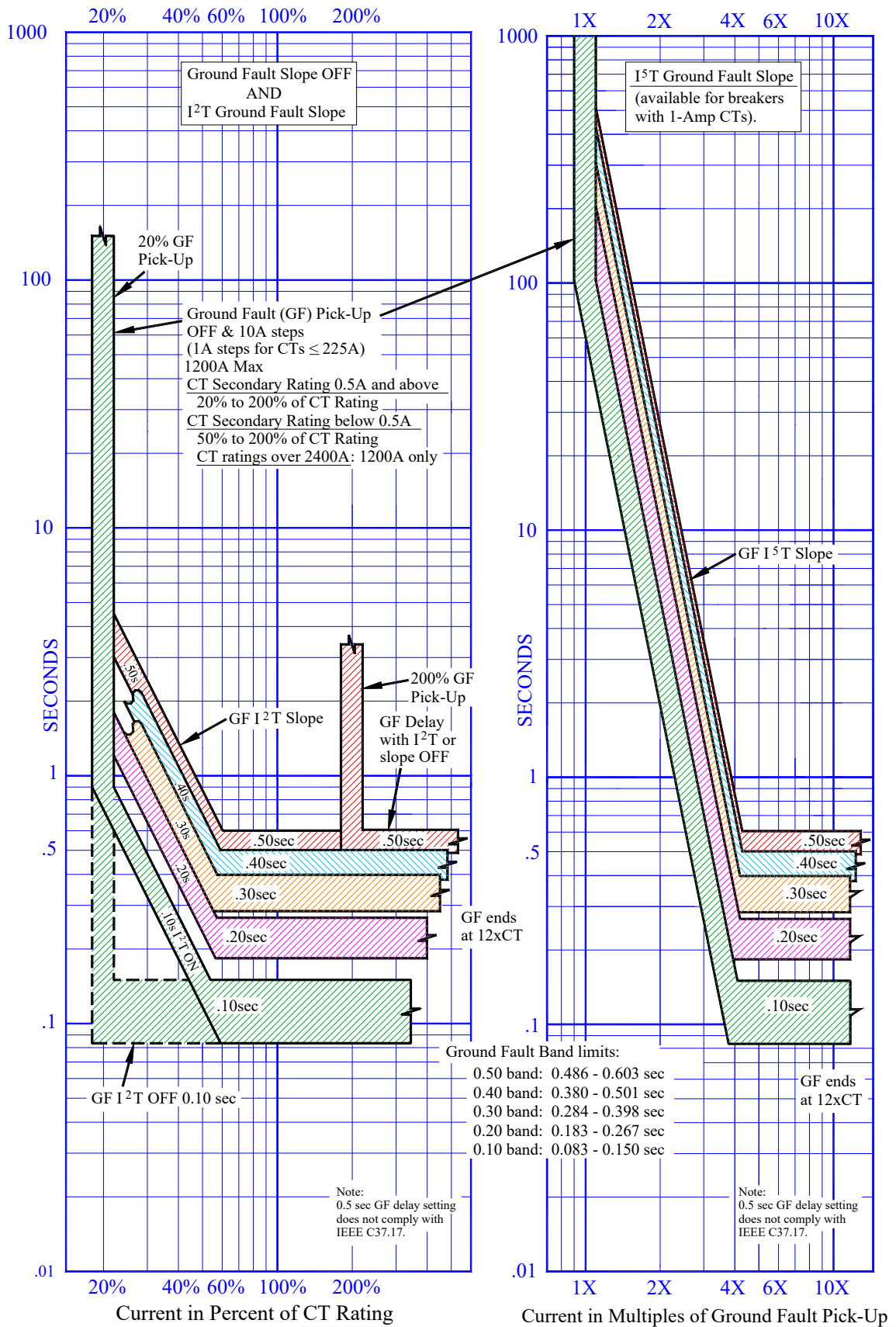

AC-PRO-II G.F. Rev 2.01 08/15/2017

Appendix A.2: Ground Fault (GF) TCC

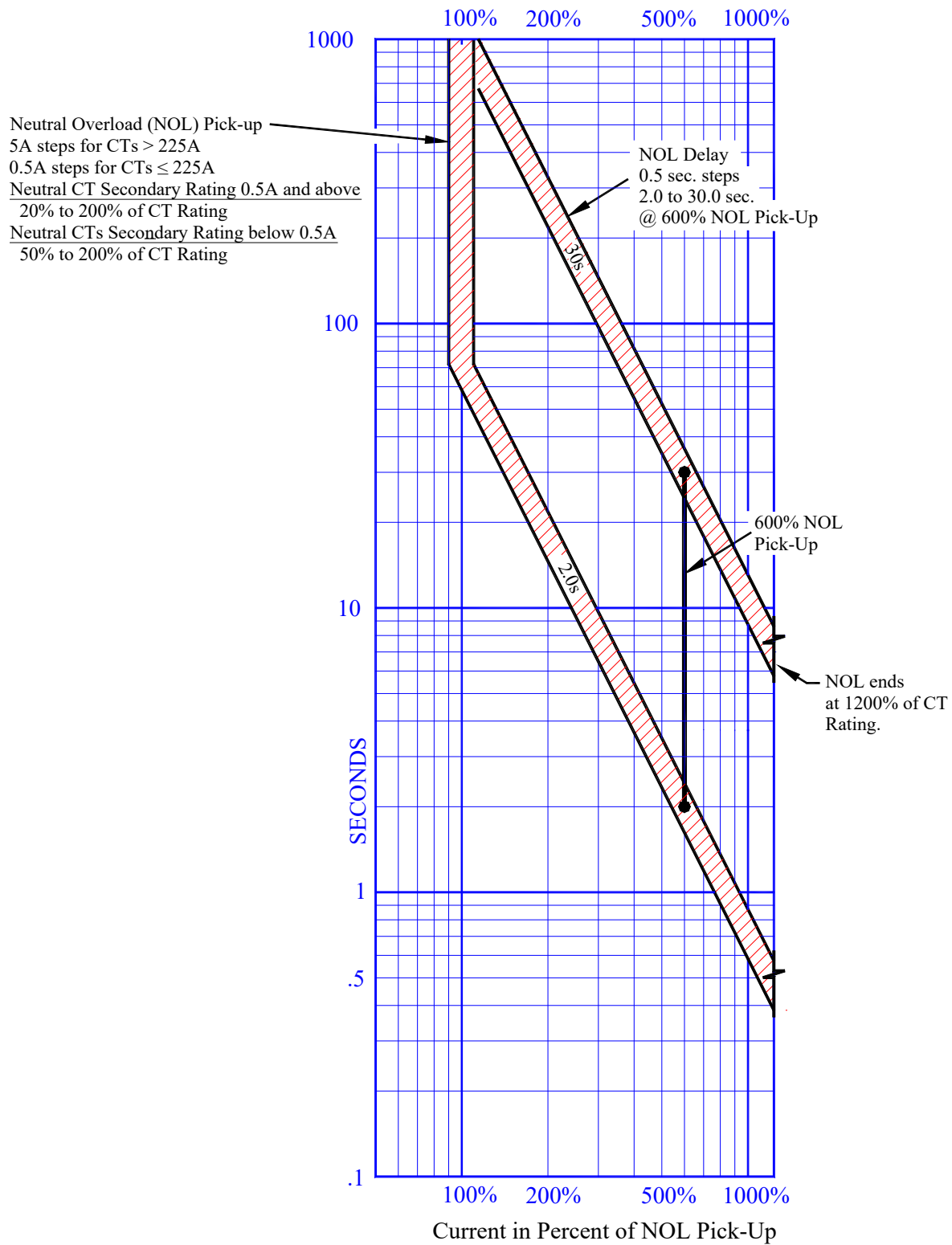

Appendix A.3: Neutral Overload (NOL) TCC
 Firmware prior to V.4.0

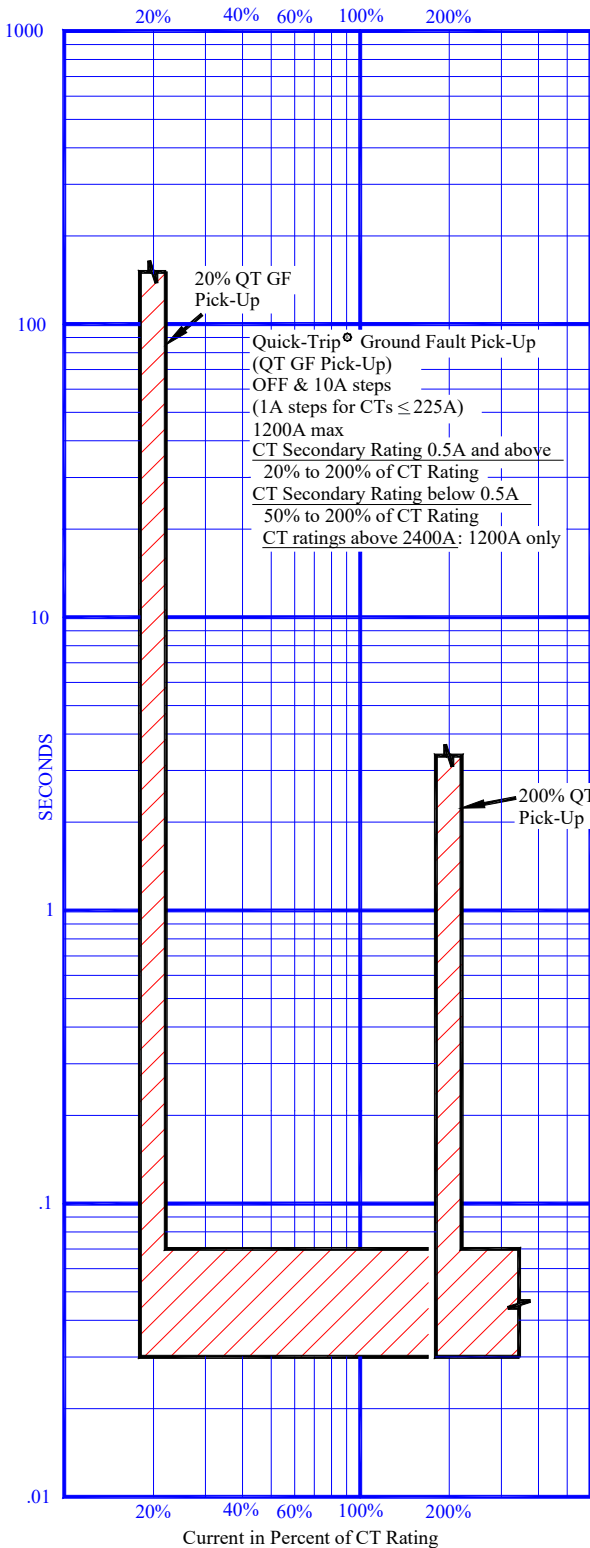

Quick-Trip® Ground Fault Time Current Curve

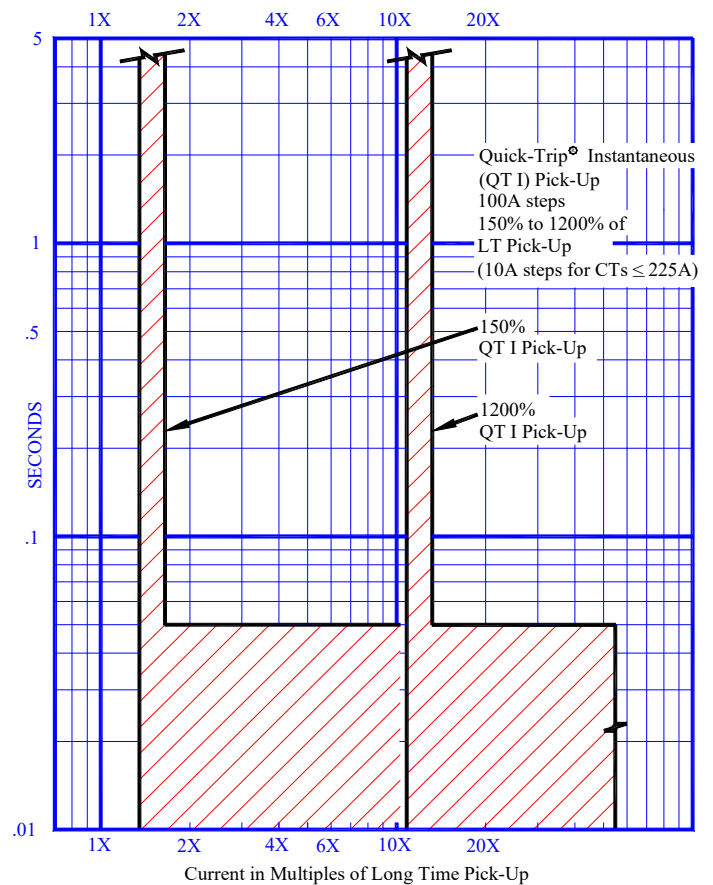

Quick-Trip® Instantaneous Time Current Curve

AC-PRO-II Q.T. Rev 1.02 01/15/2015

Appendix A. 4: QUICK-TRIP Ground Fault and QUICK-TRIP Instantaneous TCCs

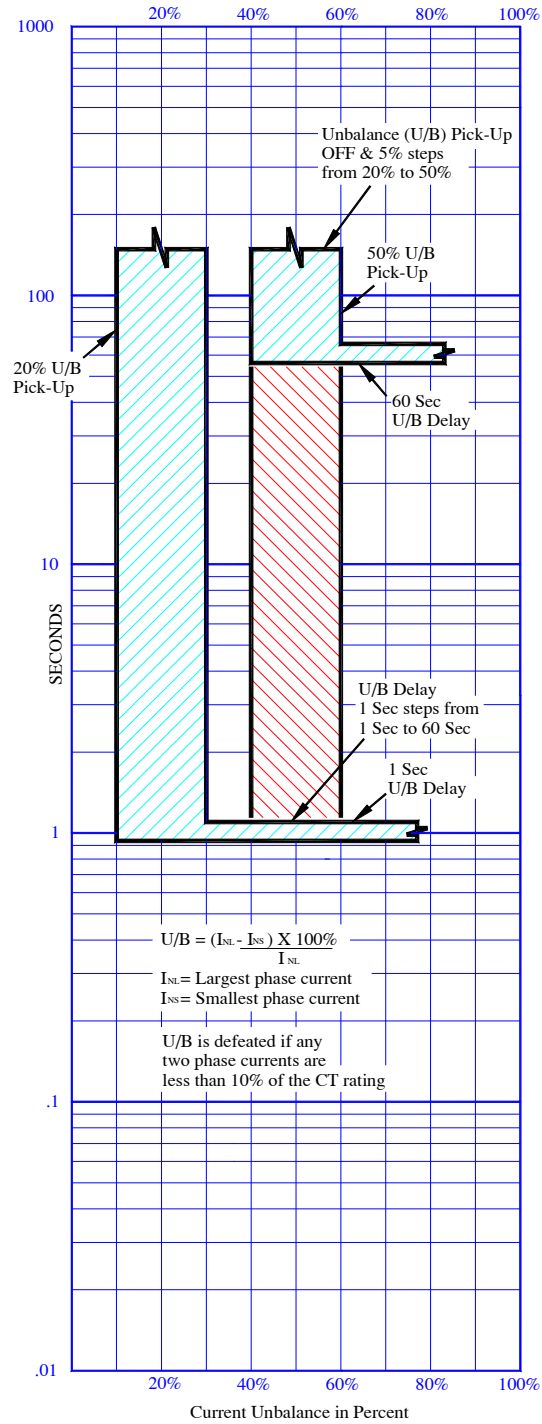

Appendix A. 5: Phase Current Unbalance TCC

UTILITYRELAY.COM



I-AC-PRO-II-QS

URC Utility Relay Company

10100 QUEENS WAY
CHAGRIN FALLS, OH 44023
USA
888.289.2864